

Name: E2021  
 Date: \_\_\_\_\_  
 Track: \_\_\_\_\_

**Track conditions**  
 Size:  Open  Med.  Tight  
 Traction:  High  Med.  Low  
 Surface:  Smooth  Med.  Bumpy

**Result**  
 Race time / Lap: \_\_\_\_\_  
 Best lap (1Lap): \_\_\_\_\_

**Front suspension**

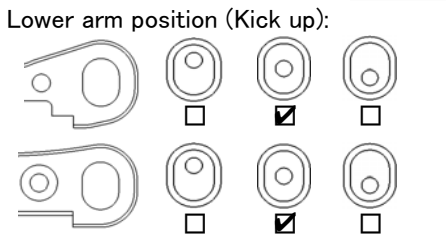
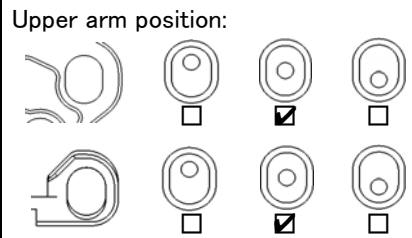
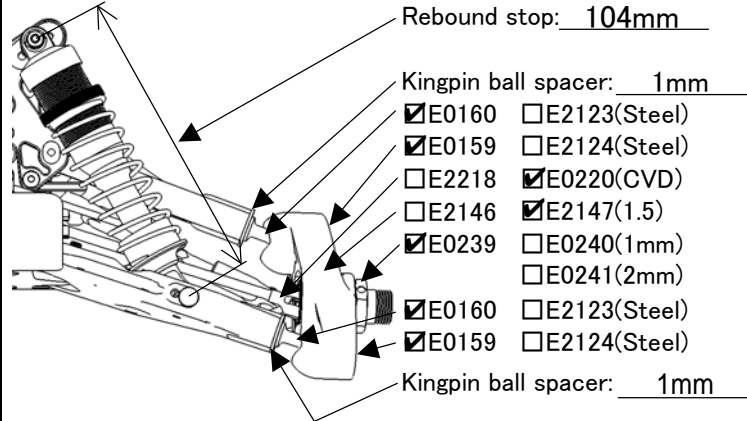

Ride height: 24mm  
 Toe angle: out  
 Lower arm plate:  
 E2144A,B  
 E2154(CFRP 1mm)  
 E2155(CFRP 1.2mm)  
 Anti roll bar: φ 2.3 (E0164)  
 Upper arm spacer: 2mm  
  
 Lower arm spacer: 0

**Front shocks**

Piston: E2525 Oil: #550  
 Spring: φ 1.6L70-9.25 (E2516)  
 Shock position:  
  
 Pivot ball position:  Front  Rear  
 Damper stay:  E2562(Aluminum)  
 E2565(CFRP)

**Steering ackerman**

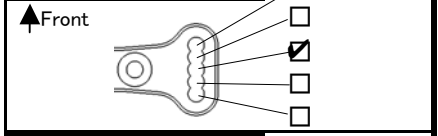

**Front upper plate**

E2148D  E2158(CFRP)

**Servo saver arm**

E2301A  E2310(Aluminum)

**Rear suspension**

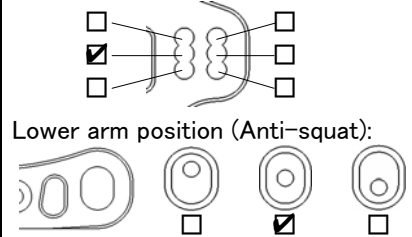
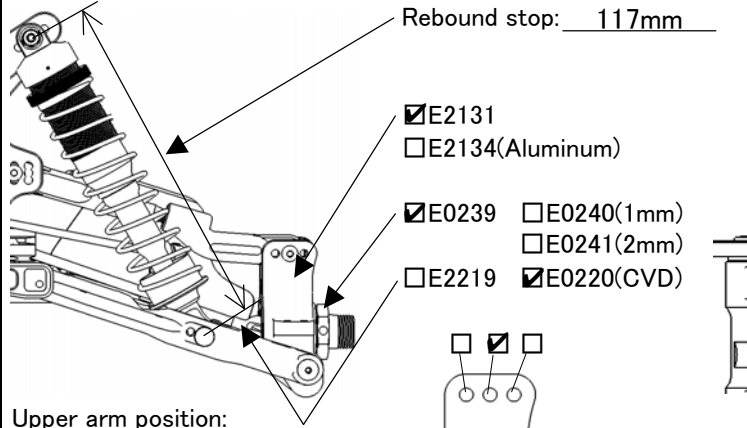

Ride height: 26mm  
 Camber angle: -3°  
 Lower arm plate:  
 E2145A,B  
 E2156(CFRP 1mm)  
 E2157(CFRP 1.2mm)  
 Anti roll bar: φ 2.7 (E0168)  
 Lower arm spacer: 0  
  
 Upright spacer: 2.5mm

**Rear shocks**

Piston: E2525 Oil: #550  
 Spring: φ 1.6L86-10.75 (E0563)  
 Shock position:  
  
 Pivot ball position:  Front  Rear  
 Damper stay:  E2563(Aluminum)  
 E2566(CFRP)

**Center shaft**

E0223,E0259  E2228,E2229

**Tension rod**

Front:  E2107A(Long)  E2107B(Short)  
 Rear:  E2148C  E0803(Rubber)

**Weight**



**Engine**  
 Type: \_\_\_\_\_ Plug: \_\_\_\_\_ Reducer: \_\_\_\_\_  
 Muffler: \_\_\_\_\_ Fuel: \_\_\_\_\_ Gasket: \_\_\_\_\_  
 Engine mount:  E0701(Standard)  Other \_\_\_\_\_

**Diff. Gear**

	Oil
Front: <input checked="" type="checkbox"/> 44/13T <input type="checkbox"/> 42/12T	#5,000
Rear: <input checked="" type="checkbox"/> 44/13T <input type="checkbox"/> 42/12T	#2,000
Center: <input type="checkbox"/> 44T <input type="checkbox"/> 46T	#5,000
<input checked="" type="checkbox"/> 47T <input type="checkbox"/> 48T	

**Tires**

	Front	Rear
Type:	_____	_____
Compound:	_____	_____
Inserts:	_____	_____
Wheel:	_____	_____

**Clutch**  3P  4P  
 Clutch bell:  13T  14T  
 Clutch shoes  C0754  E0704  E0710  E2706  
 Clutch spring  0.8  0.9  0.95  1.0  1.05  1.1

**Body/Wing**

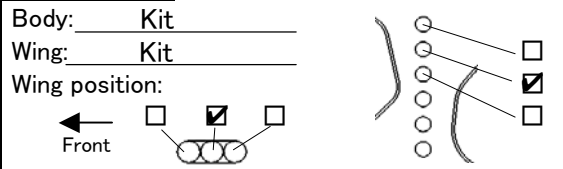

**Comments**

.....  
 .....  
 .....